







Contact your local post office before installing the mailbox to ensure its correct placement and height at the street. Generally, mailboxes are installed at a height of 41-45 inches from the road surface to inside floor of the mailbox or point of mail entry (locked designs) and are set back 6-8 inches from the front face of curb or road edge to the mailbox door.

Hardware (included)



To join the two post pieces:

-  x1, metal expansion joiner
-  x2, headless set screws
-  x2, hole plugs



To attach top bracket to the post:

-  x4, small phillips screws

To mount mailbox to the top bracket:

-  x4, large phillips screws
-  x8, large washers
-  x4, hex nuts

Tools (not included)

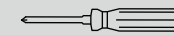
- 
- 
- Two crescent - or - open end wrench
- 
- Phillips head screwdriver

Tools (included)

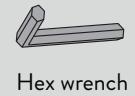

- 1a** Lay post pieces and the metal expansion joiner on a flat surface. Then, insert the joiner into one post piece making sure to align the screw holes.

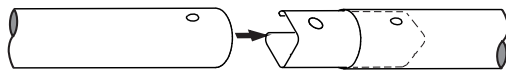

- 1b** Insert the headless set screw into the hole and tighten with the hex wrench. Tighten the screw until resistance is felt. Then, tighten at least another rotation to ensure the joiner is locked in place as shown in the diagram below.

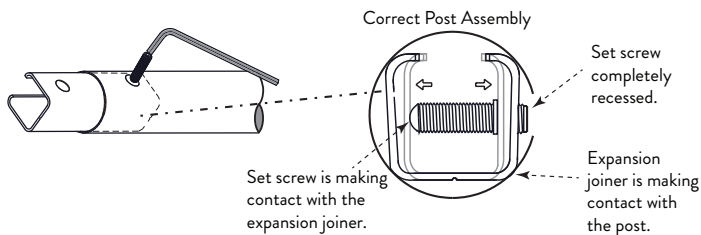

- 1c** Repeat step 1b to properly assemble the second post piece, making sure to minimize the gap between the post pieces.

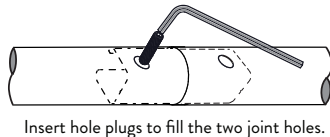

- 2** Slide the top bracket over the end of the post with bent tabs. Align the holes with the bracket and secure with 4 small phillips screws.

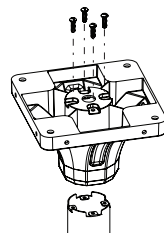

- 3** Install the assembled post into the ground, such that the point of entry for your mailbox is 41-45 inches high from the road surface.

A concrete footing is highly recommended. Typical post depths range from 12"-18" and may vary based on your installation application. Pay particular attention to the location, height, and distance from the street.

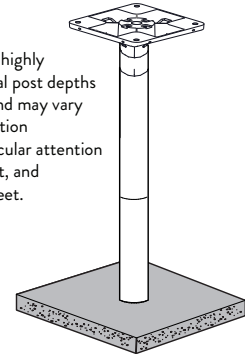

- 4** Mount the mailbox onto the top bracket and secure with 4 large phillips screws, 8 large washers, and 4 hex nuts.

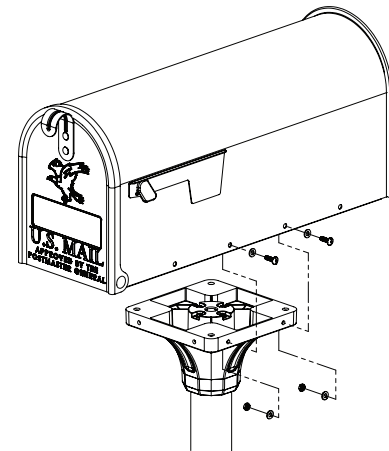

Questions, Comments, Concerns?

-  architecturalmailboxes.com
-  support@architecturalmailboxes.com

Find us on social media!

