

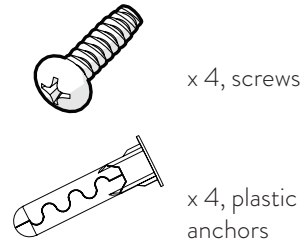

**IMPORTANT! This mailbox is intended to be mounted under an eave or another protected area.**

### Hardware (included)



### Tools (not included)

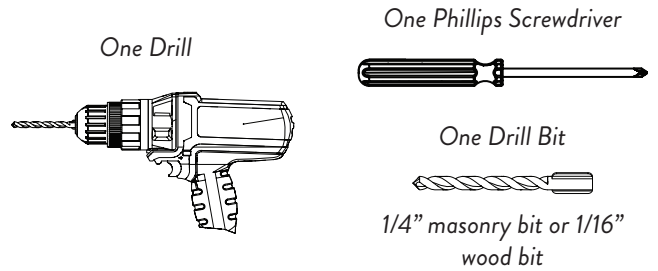

- Using the guide on the back of these instructions, mark the wall at the center of each crosshair. Use a level to ensure a straight installation (optional).

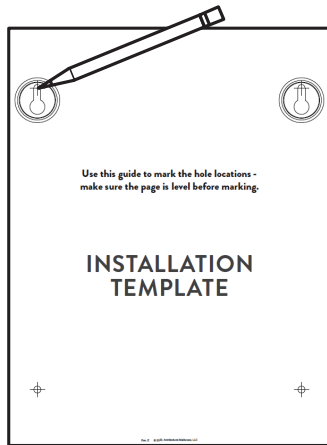

- Drill into the wall at each marked location. Use a 1/4" drill bit for brick or other masonry wall. Use a 1/16" drill bit for wood wall.

1/4" masonry bit  
- or -  
1/16" wood bit

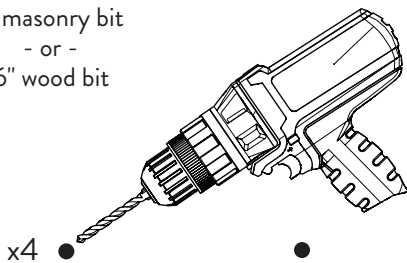

- Skip this step if installing into wood.**

Insert the included plastic anchors into the drilled holes. Gently tap them in if necessary.



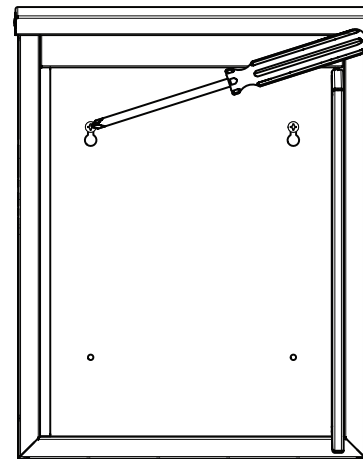

- Insert the screws into the top two drilled holes and secure with a screwdriver. Hang the mailbox onto the secured screws using the top eyelet holes on the back of the mailbox.



- While the mailbox is hanging on the top screws, insert the remaining two screws into the bottom holes and secure with a screwdriver.

### Questions, Comments, Concerns?

 [www.architecturalmailboxes.com](http://www.architecturalmailboxes.com)  
 [support@architecturalmailboxes.com](mailto:support@architecturalmailboxes.com)

### Need keys? Visit us at...

[www.architecturalmailboxes.com/keys](http://www.architecturalmailboxes.com/keys)

### Find us on social media!

    
@archmailboxes

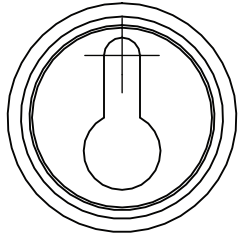
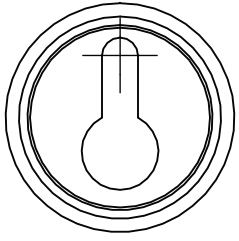

**Use this guide to mark the hole locations -  
make sure the page is level before marking.**

# INSTALLATION TEMPLATE

