

Grande Surface Mount Post (Model 5565) Installation and Assembly Instructions

Thank you for purchasing this premium mailbox post. We know you'll be satisfied with the years of service it will provide. If you have any questions about how to mount or use this post, or if you need any replacement parts, please call us directly at (800) 464-7491 or contact us at www.architecturalmailboxes.com.

Tools

Allen wrenches
(included)

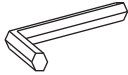

Hex wrench
(not included)

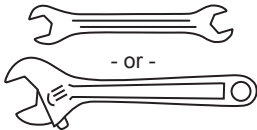

Phillips head
screwdriver
(not included)

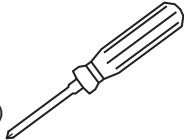

1

This post is designed to be mounted to a surface, not buried into the ground. Before you install the post, you must first have a suitable mounting surface. A concrete surface is strongly recommended. The surface should be slightly above ground level to prevent water from pooling around the post base.







If you have a pre-existing concrete pad, you can install the post using three 1/2" diameter anchor bolts designed to be inserted into cured concrete. Please refer to the instructions that come with the anchor bolts to properly install the anchors.

If you need to make a new concrete footing, you can set suitable 1/2" anchor bolts directly into the concrete before it cures. 8" long "J" bolts are recommended for this application.

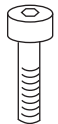
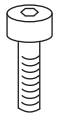
In any case, make sure the anchors are installed to match the locations of the three holes in the post base. The holes are equally spaced on an 8" diameter.

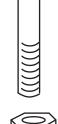
IMPORTANT NOTE: The final post location must be compliant with the USPS regulations. Typically, the mailbox floor must be 41" to 45" higher than the road surface and the mailbox face must be set back 6" to 8" from the road edge. Refer to the mailbox instructions for further details. If in question, ask your local Post Office for advice on installation location.

Hardware

-  x 4, 1" cap screw
-  x 2, 3/4" cap screw
(may be pre-assembled onto collar)
-  x 6, 3/4" set screw
-  x 3, 1/4" set screw
-  x 4, 1/4" lock washer
-  x 4, 5/16" flat washer
-  x 4, 1-1/2" Phillips screw
-  x 4, 5/16" hex nut

2

Attach the post base to the mounting surface prepared in Step 1. **Do not** remove the protective packaging material from the post. Secure the base using the nuts and washers included with your anchors.

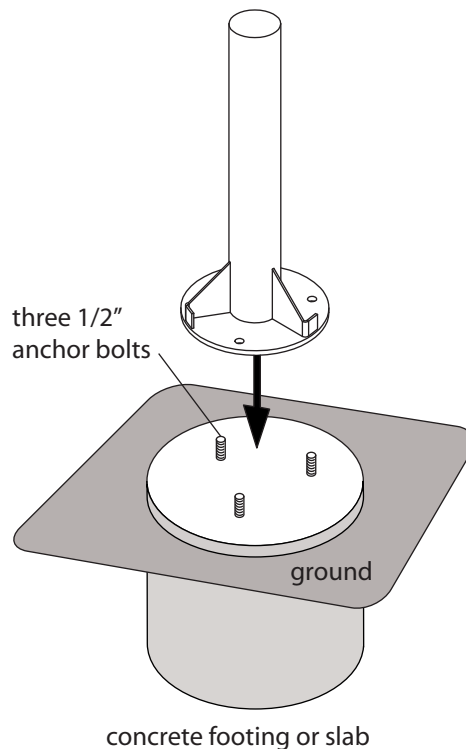

3

Slide the decorative shroud over the post base. After the shroud is resting in place, remove the protective packaging material from the post. Secure the base shroud to the post base using the six 3/4" set screws. The bottom three set screws must be secured against the flat portions of the base. Ensure that the set screws are equally tightened to properly center the shroud on the post.

